





FOR INFORMATION ONLY

LEGEND

-  PROPOSED RETAINING WALLS
-  EXISTING RETAINING WALL
-  FUTURE RETAINING WALLS
-  FINISHED GROUND LEVELS
-  RETAINING WALL REFERENCE
-  PROPOSED LOT LEVEL (FLAT LOT)
-  PROPOSED AVERAGE LOT LEVEL (SLOPING LOT)
-  PROPOSED CONSERVATION FENCING
-  ACCESS CONTROL FENCE - 1.2m HIGH RINGLOCK AND STAR IRON PICKET FENCE WITH 50% BLACK SHADECLOTH ATTACHED (FENCE TO BE INSTALLED ON COMPLETION OF WORKS, FENCE TO BE TERMINATED AT RETAINING WALL, NOISE WALL, BOLLARDS OR OTHER FENCE)

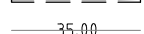
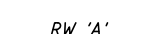
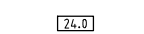
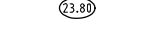
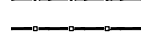
WALL SETOUT INFORMATION

WALL No.	START VERGE RL	FRONT OF WALL RL	BACK OF WALL RL	TOP OF WALL RL	END VERGE RL	LENGTH	NO. OF COURSES
3	22.26	22.54	22.91	22.96	-	28.5	2
4	-	20.32	20.69	20.74	19.73	28.5	2
5	22.63	22.91	23.28	23.33	-	28.5	2
6	-	20.69	21.06	21.11	20.08	28.5	2
7	23.07	23.28	23.65	23.70	-	28.5	2
8	23.31	23.65	24.02	24.07	-	28.5	2
9	-	21.06	21.43	21.48	20.37	28.5	2
10	23.68	24.02	24.39	24.44	-	28.5	2
11	-	21.43	21.80	21.85	20.72	28.5	2
12	24.05	24.39	24.76	24.81	-	28.5	2
13	-	21.80	22.17	22.22	21.26	28.5	2
14	-	22.17	22.54	22.59	21.67	28.5	3
17	-	24.02	24.39	24.44	23.61	18.7	2
21	-	22.47	22.84	22.89	-	5.0	2
24	-	24.69	25.06	25.11	-	5.0	2
25	-	23.21	23.58	23.63	22.89	28.5	2
26	-	25.06	25.43	25.48	-	5.0	2
27	-	23.58	23.95	24.00	23.29	28.5	2
28	-	25.43	25.80	25.85	-	5.0	2
29	-	23.95	24.32	24.37	23.53	28.5	2
30	-	25.80	26.17	26.22	-	5.0	2
31	-	26.17	26.54	26.59	-	5.0	2
32	-	24.32	24.69	24.74	24.06	28.5	2
34	-	25.80	26.17	26.22	-	5.0	2
37	24.63	24.96	25.33	25.38	-	18.5	2
38	23.91	24.22	24.59	24.64	-	18.5	2

REFER STANDARD WALL DETAILS FOR TYPICAL SECTION

NOTES:

- RETAINING WALLS OVER 1.0m SHALL HAVE A 1.2m HIGH RINGLOCK AND STAR IRON PICKET FENCE INSTALLED ON TOP.
- TO BE READ IN CONJUNCTION WITH RETAINING WALL LONGSECTION, STANDARD RETAINING WALL DETAILS AND EARTHWORKS DRAWINGS.
- ADD EXTRA BLOCKS AS INDICATED ON ELECTRICAL DRAWING

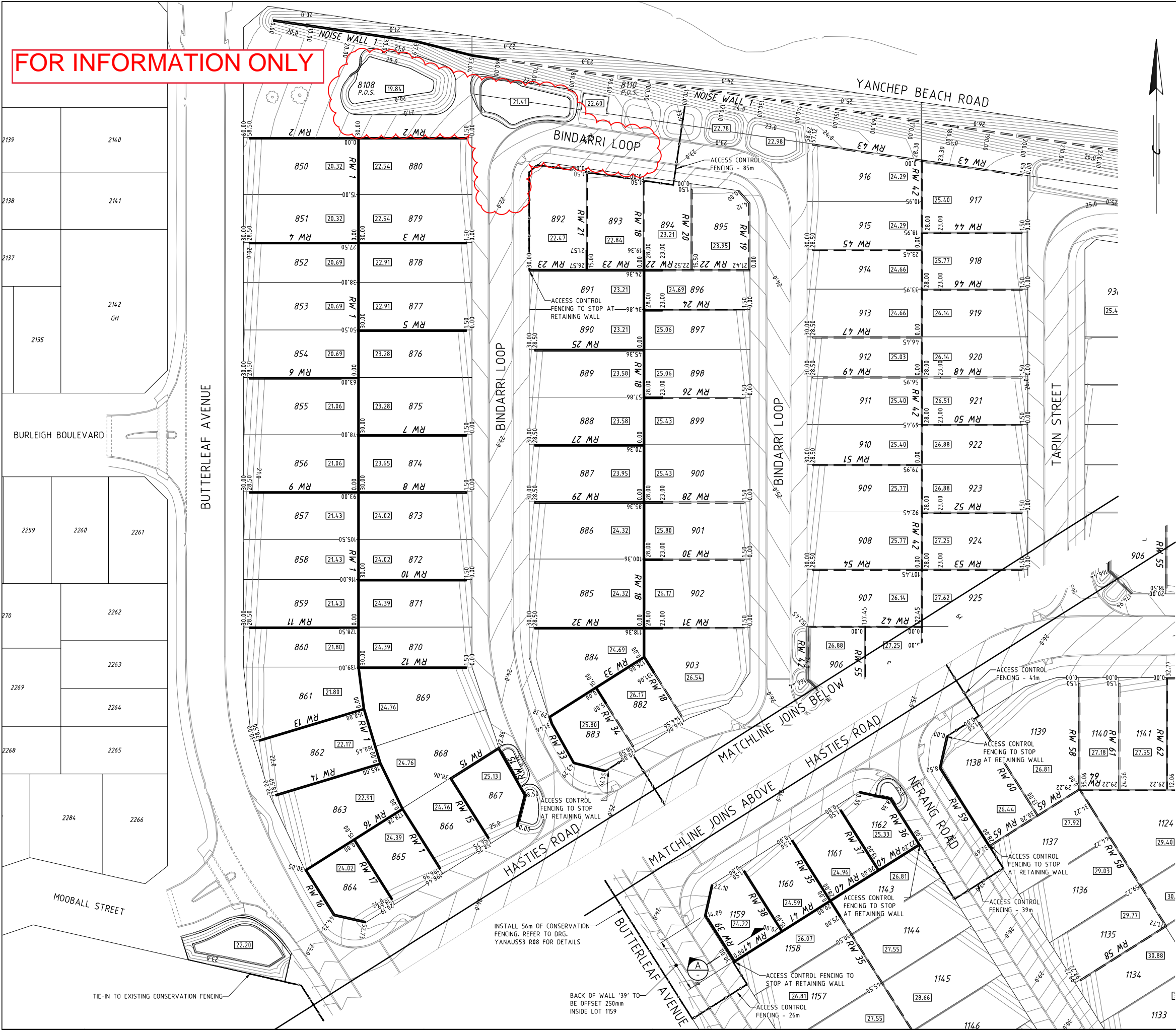
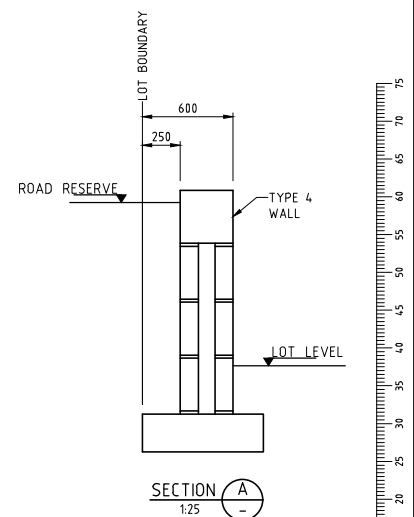

<p>Copyright</p> <p>"This document shall remain the property of Development Engineering Consultants Pty. Ltd. The document may only be used for the purpose for which it was commissioned and in accordance with the terms of engagement for the commission. Unauthorised use of this document in any way is prohibited"</p>	<table border="1"> <tr><th>No.</th><th>DATE</th><th>BY</th><th>REVISION</th></tr> <tr><td>2</td><td>22/12/21</td><td>PMS</td><td>CONTOURS & DRAINAGE SWALES AMENDED TO SUIT EMERGENCY ACCESS TRACK</td></tr> <tr><td>1</td><td>10/11/21</td><td>BVS</td><td>RETAINING WALL 59 EXTENDED</td></tr> <tr><td>0</td><td>21/10/21</td><td>PMS</td><td>ISSUED FOR CONSTRUCTION</td></tr> <tr><td>8</td><td>29/09/21</td><td>PMS</td><td>'RW 36' WALL TYPE AND ALIGNMENT AMENDED</td></tr> <tr><td>A</td><td>17/08/21</td><td>PMS</td><td>INITIAL ISSUE</td></tr> </table>	No.	DATE	BY	REVISION	2	22/12/21	PMS	CONTOURS & DRAINAGE SWALES AMENDED TO SUIT EMERGENCY ACCESS TRACK	1	10/11/21	BVS	RETAINING WALL 59 EXTENDED	0	21/10/21	PMS	ISSUED FOR CONSTRUCTION	8	29/09/21	PMS	'RW 36' WALL TYPE AND ALIGNMENT AMENDED	A	17/08/21	PMS	INITIAL ISSUE	<p>CLIENT:</p> <p>DEVELOPMENT WA</p>	 <p>DEVELOPMENT ENGINEERING CONSULTANTS</p> <p>SUITE 3, 123A COLIN ST. WEST PERTH, 6005 WESTERN AUSTRALIA Ph: (08) 9481 1900 Fax: (08) 9481 1700</p>	<p>PROJECT:</p> <p>LOT 9033 YANCHEP BEACH ROAD YANCHEP JINDOWIE - STAGE 22A</p> <p>W.A.P.C. No. - 152955</p>	<p>DRAWING:</p> <p>EARTHWORKS RETAINING WALL LAYOUT PLAN</p> <p>CAD DRAWING DO NOT MANUALLY ALTER</p>	<table border="1"> <tr><th>SCALE</th><th>DRAWN</th><th>CHECK</th><th>REV No.</th></tr> <tr><td>1:500</td><td>PMS</td><td>RDG</td><td>2</td></tr> <tr><th>DATE</th><th>DESIGNED</th><th>APPROVED</th><td></td></tr> <tr><td>AUG '21</td><td>PMS</td><td>RDG</td><td></td></tr> <tr><th>PROJECT NUMBER</th><th>DRAWING NUMBER</th><td colspan="2"></td></tr> <tr><td colspan="2">YANAUS53 E02</td><td colspan="2"></td></tr> </table> <p style="font-size: small;">S:\Auss\YANAUS53\Drawings\YANAUS53 E02.dwg 22/12/2021</p>	SCALE	DRAWN	CHECK	REV No.	1:500	PMS	RDG	2	DATE	DESIGNED	APPROVED		AUG '21	PMS	RDG		PROJECT NUMBER	DRAWING NUMBER			YANAUS53 E02			
No.	DATE	BY	REVISION																																																			
2	22/12/21	PMS	CONTOURS & DRAINAGE SWALES AMENDED TO SUIT EMERGENCY ACCESS TRACK																																																			
1	10/11/21	BVS	RETAINING WALL 59 EXTENDED																																																			
0	21/10/21	PMS	ISSUED FOR CONSTRUCTION																																																			
8	29/09/21	PMS	'RW 36' WALL TYPE AND ALIGNMENT AMENDED																																																			
A	17/08/21	PMS	INITIAL ISSUE																																																			
SCALE	DRAWN	CHECK	REV No.																																																			
1:500	PMS	RDG	2																																																			
DATE	DESIGNED	APPROVED																																																				
AUG '21	PMS	RDG																																																				
PROJECT NUMBER	DRAWING NUMBER																																																					
YANAUS53 E02																																																						

FOR INFORMATION ONLY

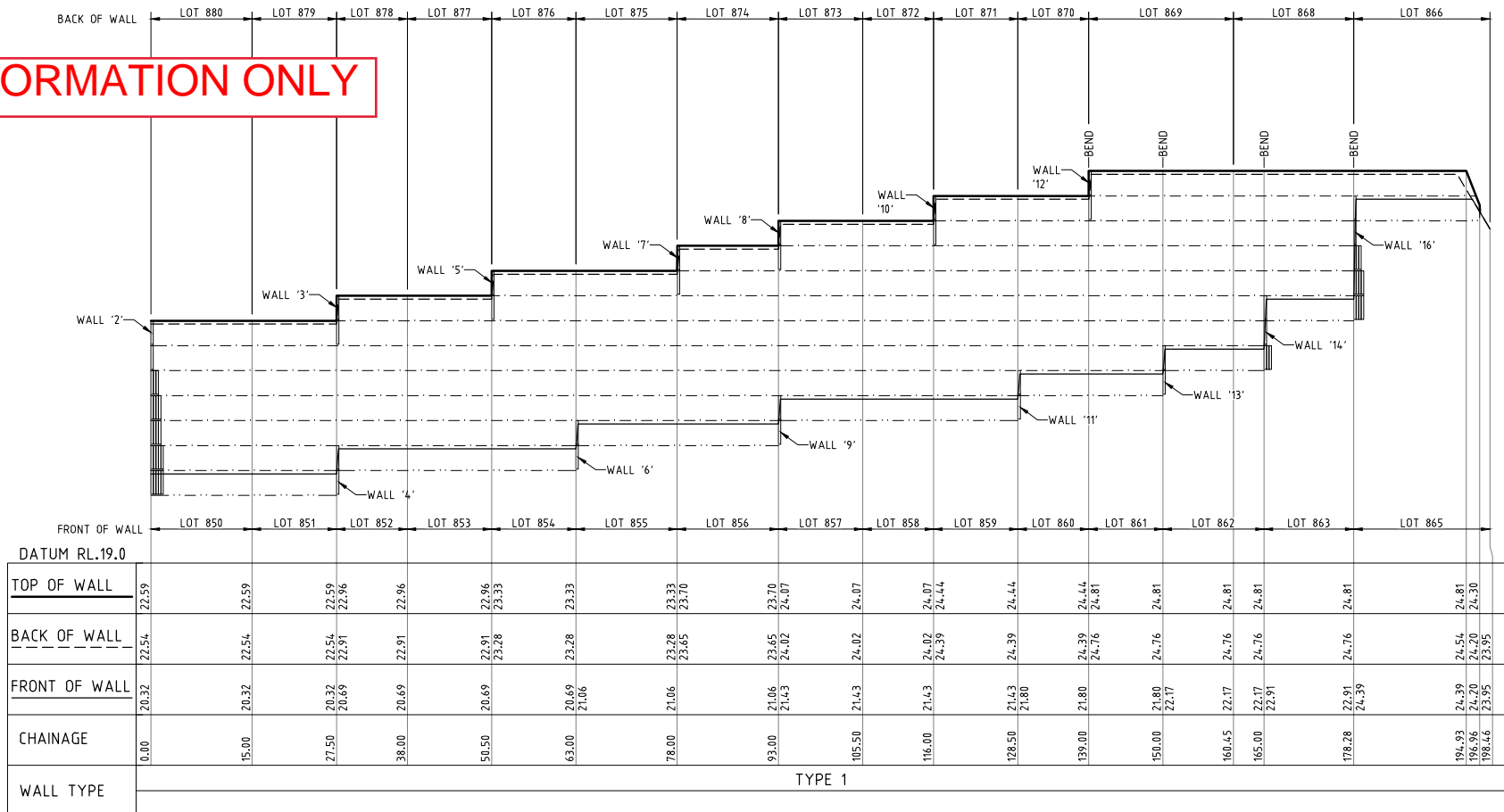

RETAINING WALL '1'
HORIZ.-1500
VERT.-150

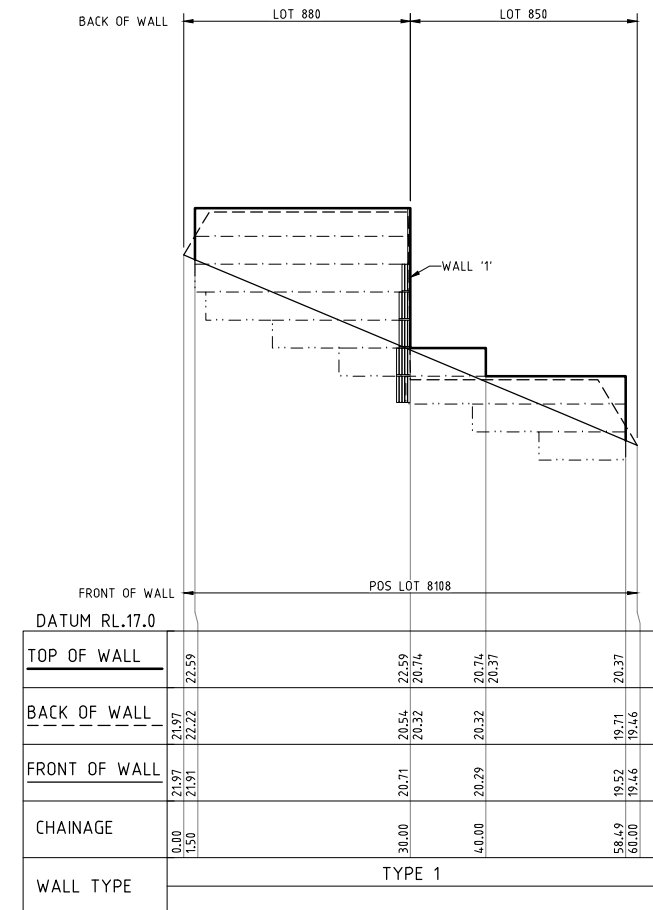

RETAINING WALL '2'
HORIZ.-1500
VERT.-150

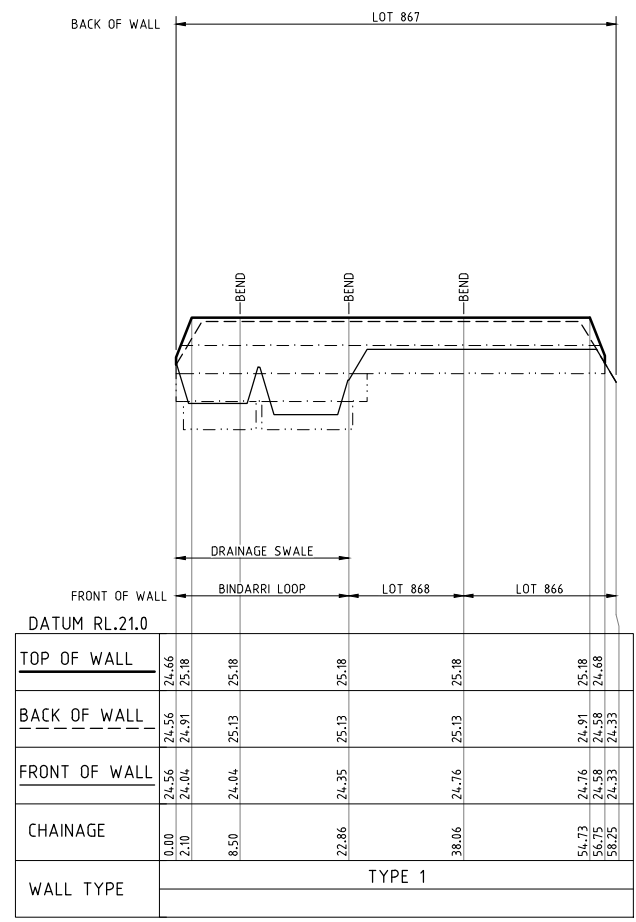

RETAINING WALL '15'
HORIZ.-1500
VERT.-150

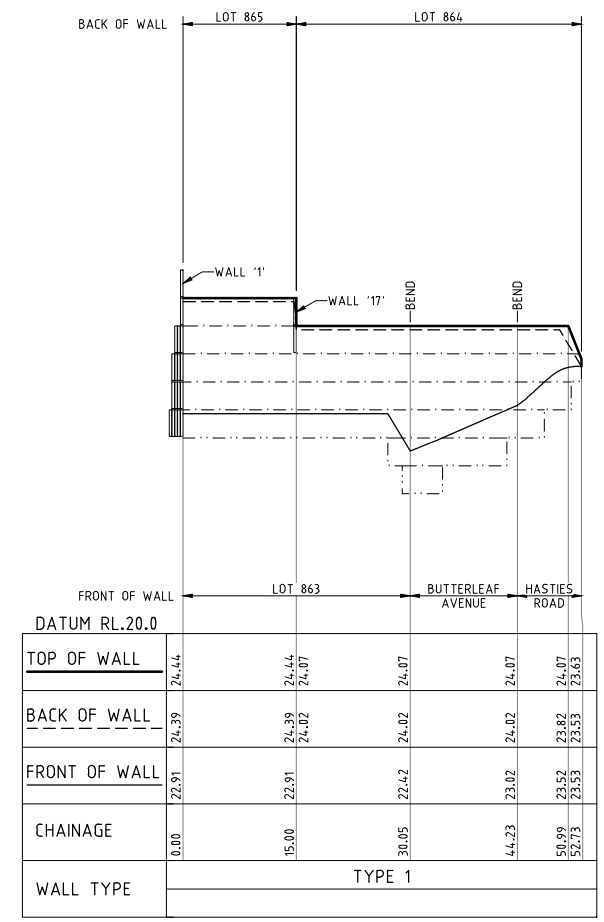

RETAINING WALL '16'
HORIZ.-1500
VERT.-150

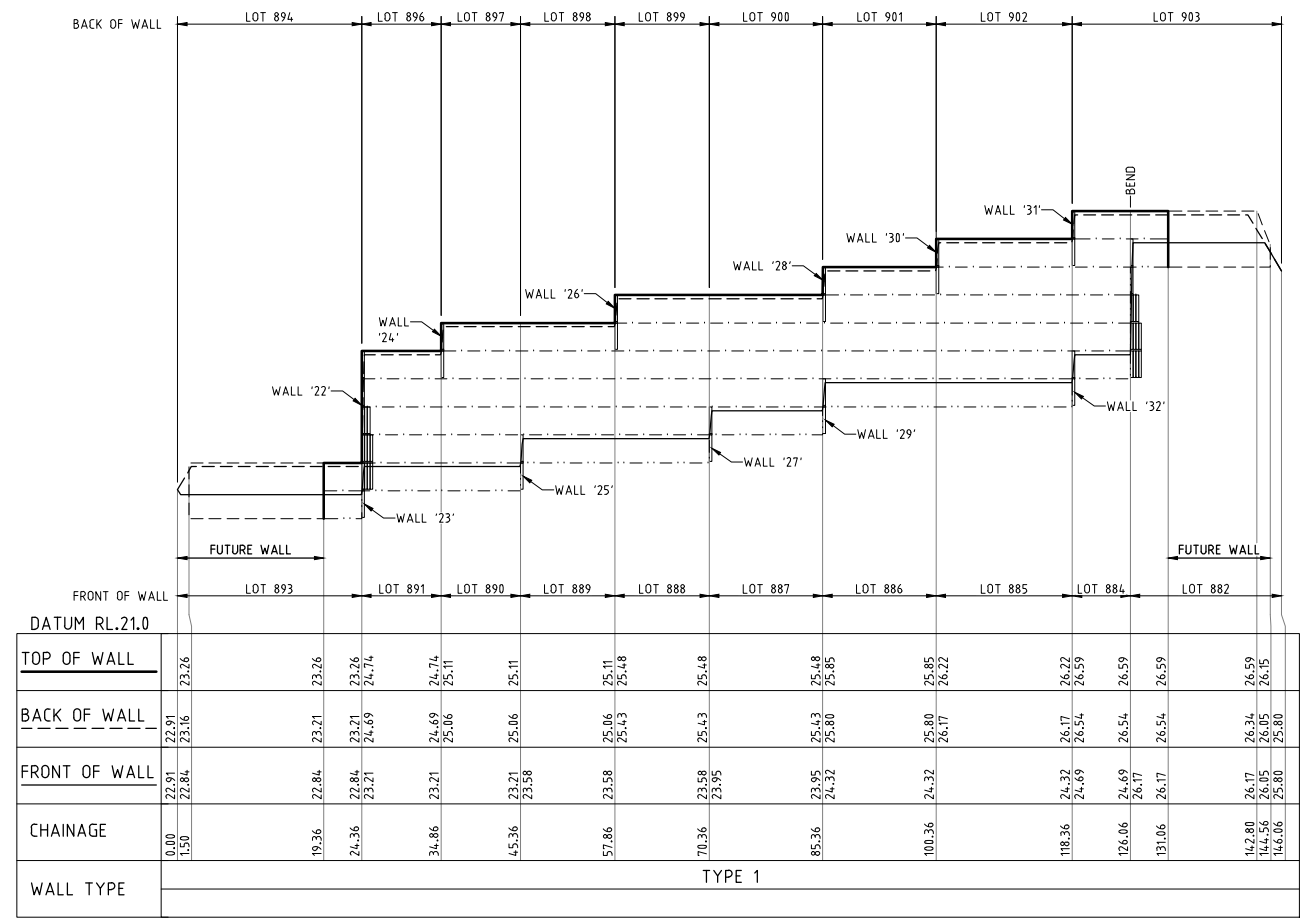

RETAINING WALL '18'
HORIZ.-1500
VERT.-150

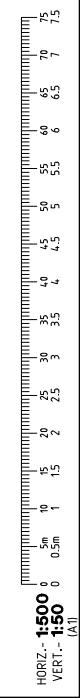

Copyright	This document shall remain the property of Development Engineering Consultants Pty. Ltd. The document may only be used for the purpose for which it was commissioned and in accordance with the terms of engagement for the commission. Unauthorised use of this document in any way is prohibited.		
No.	DATE	BY	REVISION
A	17/08/21	PMS	INITIAL ISSUE
B	21/10/21	PMS	ISSUED FOR CONSTRUCTION

CLIENT:
DEVELOPMENT WA

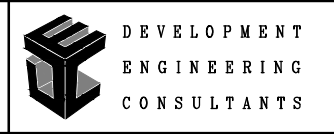

SUITE 3, 123A COLIN ST.
WEST PERTH, 6005
WESTERN AUSTRALIA
Ph: (08) 9481 1900
Fax: (08) 9481 1700

PROJECT:
**LOT 9033 YANCHEP BEACH ROAD
YANCHEP
JINDOWIE - STAGE 22A**
W.A.P.C. No. - 152955

DRAWING:
**EARTHWORKS
RETAINING WALL LONGSECTIONS
SHEET 1 OF 2**
CAD DRAWING DO NOT MANUALLY ALTER

SCALE	H-1500, V-150	DRAWN	PMS	CHECK	RDG	REV No.	0
DATE	AUG '21	DESIGNED	PMS	APPROVED	RDG		
PROJECT NUMBER						DRAWING NUMBER	
YANAUS53 E03						YANAUS53 E03	

FOR INFORMATION ONLY

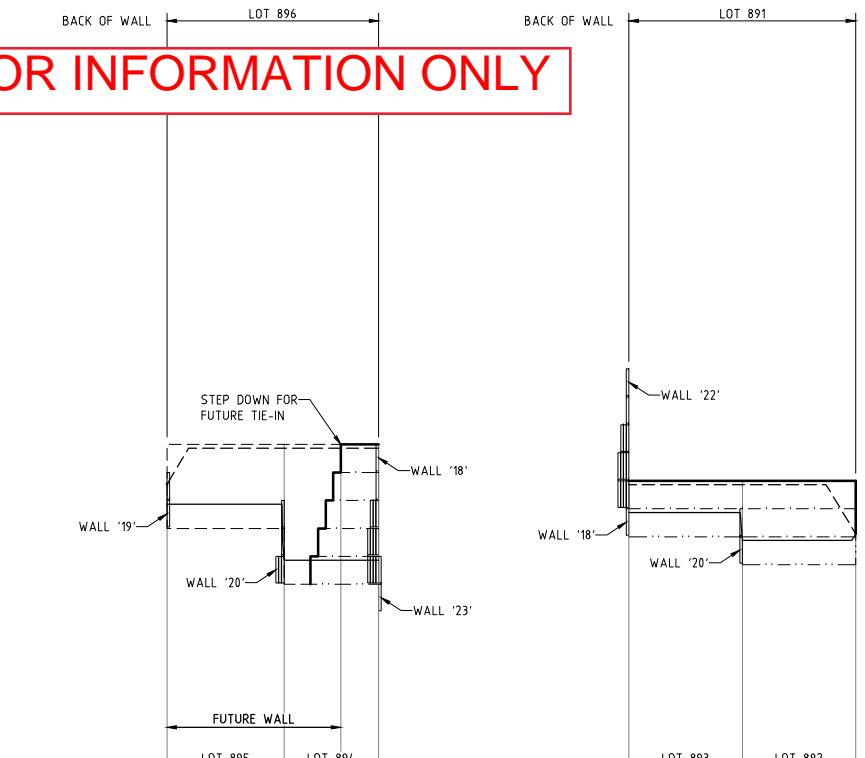

DATUM RL.20.0

TOP OF WALL	24.74	24.74	24.74	24.74
BACK OF WALL	24.21	24.69	24.69	24.74
FRONT OF WALL	23.95	23.95	23.21	23.21
CHAINAGE	0.00	15.50	23.00	28.00
WALL TYPE	TYPE 1			

RETAINING WALL '22'
HORIZ.-1:500
VERT.-1:50

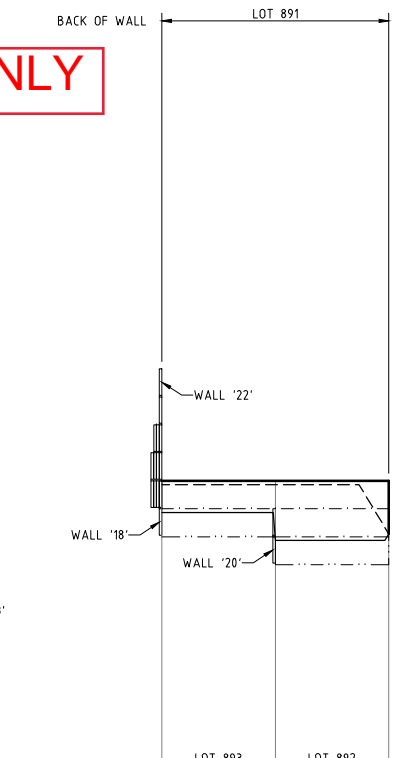

DATUM RL.19.0

TOP OF WALL	23.26	23.26	23.26	23.26
BACK OF WALL	23.21	23.21	22.56	22.56
FRONT OF WALL	22.84	22.84	22.47	22.47
CHAINAGE	0.00	15.00	30.00	
WALL TYPE	TYPE 1			

RETAINING WALL '23'
HORIZ.-1:500
VERT.-1:50

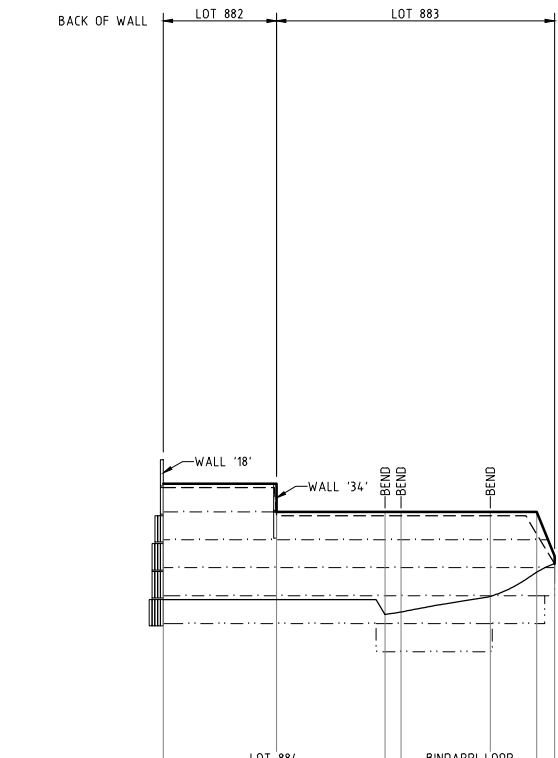

DATUM RL.22.0

TOP OF WALL	26.22	26.22	25.85	25.85	25.85	25.85	25.85	25.85
BACK OF WALL	26.17	26.17	25.80	25.85	25.85	25.85	25.85	25.85
FRONT OF WALL	24.69	24.69	24.52	24.73	24.73	25.05	25.05	25.26
CHAINAGE	0.00	15.00	29.38	31.46	43.29	49.44	51.79	
WALL TYPE	TYPE 1							

RETAINING WALL '18'
HORIZ.-1:500
VERT.-1:50

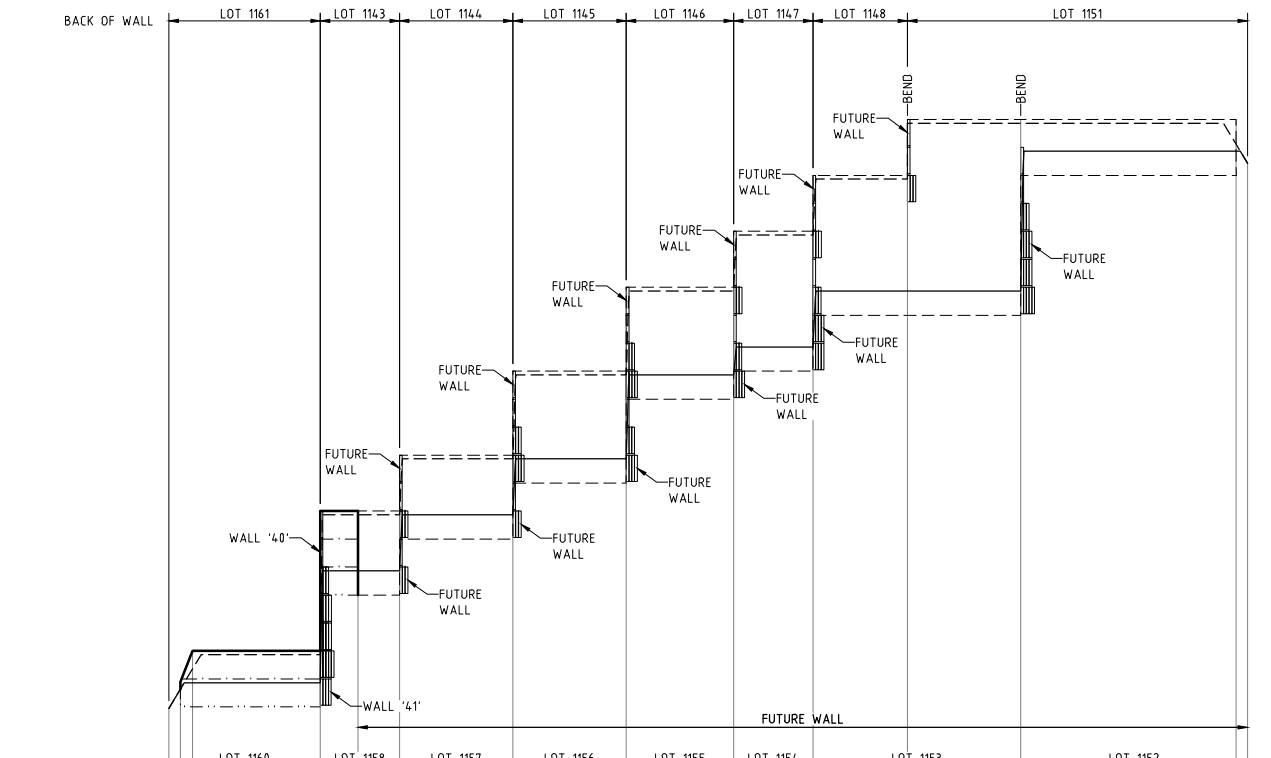

DATUM RL.23.0

TOP OF WALL	24.60	25.01	26.86	26.86	26.86	27.60	27.60	28.71	28.71	29.82	29.82	30.56	30.56	31.30	31.30	31.30	32.04	32.04	32.04
BACK OF WALL	24.25	24.96	26.81	26.86	26.86	26.81	26.86	27.55	27.55	28.66	28.66	29.77	29.77	30.51	30.51	31.25	31.25	31.99	31.99
FRONT OF WALL	24.50	24.50	26.07	26.07	26.07	26.81	26.81	27.55	27.55	28.66	28.66	29.77	29.77	30.51	30.51	31.25	31.25	31.99	31.99
CHAINAGE	0.00	1.50	3.14	20.00	30.50	30.50	45.50	60.50	74.70	85.20	97.70	112.70	141.20	142.70					
WALL TYPE	TYPE 1																		

RETAINING WALL '35'
HORIZ.-1:500
VERT.-1:50

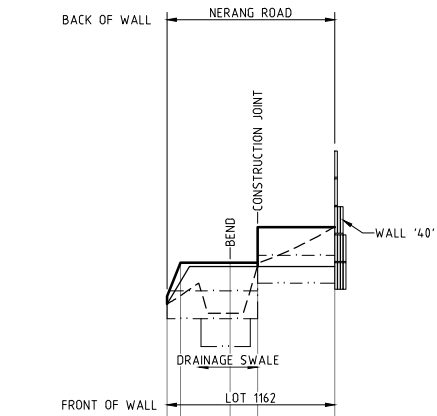

DATUM RL.23.0

TOP OF WALL	24.84	25.38	25.38	25.85	25.85
BACK OF WALL	24.34	24.71	25.34	25.86	25.86
FRONT OF WALL	24.19	24.71	25.33	25.33	25.33
CHAINAGE	0.00	17.18	8.36	12.00	22.20
WALL TYPE	TYPE 1		TYPE 2		

RETAINING WALL '36'
HORIZ.-1:500
VERT.-1:50

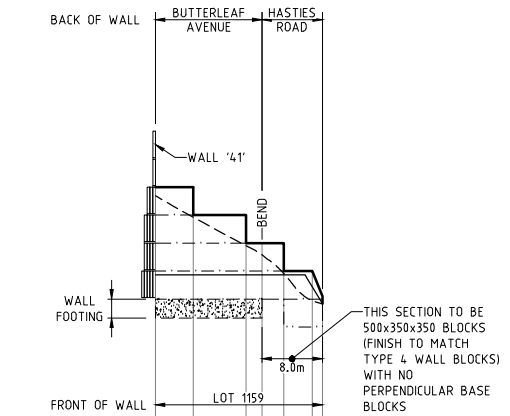

DATUM RL.22.0

TOP OF WALL	25.38	25.81	25.81	26.64	26.64	26.64	26.64	26.64	26.64	26.64	26.64	26.64	26.64	26.64	26.64	26.64	26.64	26.64	26.64	
BACK OF WALL	25.27	24.98	24.61	24.64	24.64	24.64	24.64	24.64	24.64	24.64	24.64	24.64	24.64	24.64	24.64	24.64	24.64	24.64	24.64	
FRONT OF WALL	24.22	24.22	24.61	24.64	24.64	24.64	24.64	24.64	24.64	24.64	24.64	24.64	24.64	24.64	24.64	24.64	24.64	24.64	24.64	
CHAINAGE	0.00	5.00	12.00	16.09	17.00	20.77	22.10	23.84	23.94											
WALL TYPE	TYPE 4										TYPE 1									

RETAINING WALL '39'
HORIZ.-1:500
VERT.-1:50

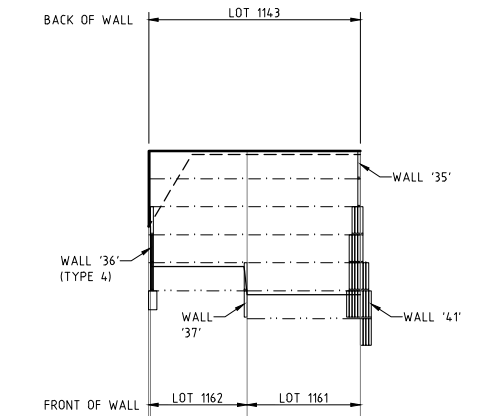

DATUM RL.23.0

TOP OF WALL	26.86	26.86	26.86	26.86	26.86
BACK OF WALL	25.86	25.90	26.86	26.81	26.86
FRONT OF WALL	25.86	25.33	26.81	26.81	26.86
CHAINAGE	0.00	0.75	13.00	28.00	28.00
WALL TYPE	TYPE 1				

RETAINING WALL '40'
HORIZ.-1:500
VERT.-1:50

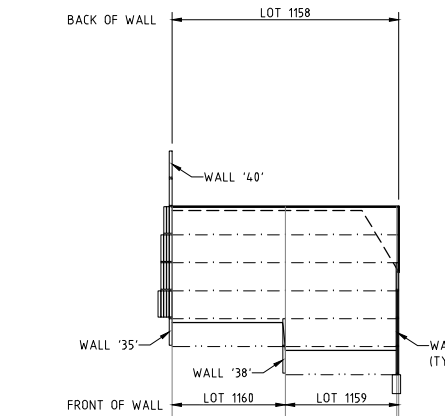

DATUM RL.23.0

TOP OF WALL	26.12	26.12	26.12	26.12	26.12
BACK OF WALL	26.07	26.07	26.07	26.12	26.12
FRONT OF WALL	24.59	24.59	26.07	26.07	26.12
CHAINAGE	0.00	15.00	29.75	30.00	30.00
WALL TYPE	TYPE 1				

RETAINING WALL '41'
HORIZ.-1:500
VERT.-1:50

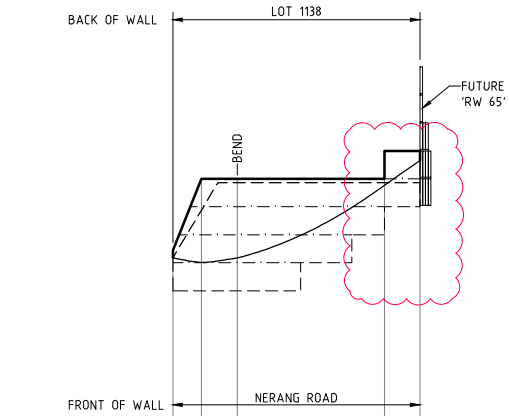

DATUM RL.23.0

TOP OF WALL	25.45	26.49	26.49	26.86	26.86
BACK OF WALL	25.45	26.08	26.44	26.44	26.86
FRONT OF WALL	25.39	26.44	26.44	26.44	26.86
CHAINAGE	0.00	3.78	8.50	28.00	32.69
WALL TYPE	TYPE 1				

RETAINING WALL '59'
HORIZ.-1:500
VERT.-1:50



Copyright	This document shall remain the property of Development Engineering Consultants Pty. Ltd. The document may only be used for the purpose for which it was commissioned and in accordance with the terms of engagement for the commission. Unauthorised use of this document in any way is prohibited.		
No.	DATE	BY	REVISION
1	10/11/21	BVS	EXTENDED RETAINING WALL 59
0	21/10/21	PMS	ISSUED FOR CONSTRUCTION
B	29/09/21	PMS	'RW 36' WALL TYPE AND ALIGNMENT AMENDED
A	17/08/21	PMS	INITIAL ISSUE

CLIENT:
DEVELOPMENT WA

DEVELOPMENT ENGINEERING CONSULTANTS

SUITE 3, 123A COLIN ST.
WEST PERTH, 6005
WESTERN AUSTRALIA
Ph: (08) 9481 1900
Fax: (08) 9481 1700

PROJECT:
**LOT 9033 YANCHEP BEACH ROAD
YANCHEP
JINDOWIE - STAGE 22A**
W.A.P.C. No. - 152955

DRAWING:
**EARTHWORKS
RETAINING WALL LONGSECTIONS
SHEET 2 OF 2**
CAD DRAWING DO NOT MANUALLY ALTER

SCALE	H-1:500, V-1:50	DRAWN	PMS	CHECK	RDG	REV No.	1
DATE	AUG '21	DESIGNED	PMS	APPROVED	RDG		
PROJECT NUMBER	DRAWING NUMBER		YANAUS53 E04				

FOR INFORMATION ONLY

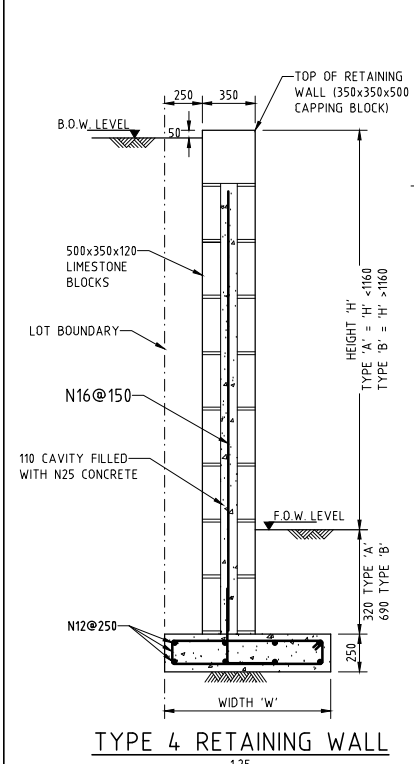

TYPE 4 WALL DIMENSIONS

HEIGHT (H)	COURSES	WIDTH 'W'
3330	9	3000
2960	8	2000
2590	7	1500
2220	6	1250
1850	5	1000
<1480	<5	800

TYPE 1 & 2 WALL DIMENSIONS

NO. OF COURSES	TOTAL HEIGHT "H" + "E"	MAX. EFFECTIVE HEIGHT "H"	MIN. BASE WIDTH "W"	
			TYPE 1	TYPE 2
2*	720	520(A)	720	350(B)
3	1090	740	1000	720
4	1460	1110	1370	1000
5	1830	1480	1370	1000
6	2200	1850	1740	1090
7	2570	2220	1830	1370
8	2940	2590	2000	1370
9	3310	2960	2200	1740
10	3680	3330	2460	1740
11	4050	3700	2760	2200
12	4420	4070	2850	2200
13	4790	4440	3130	2480
14	5160	4790	3410	
15	5530	5180	3780	
16	5900	5550	4050	
17	6270	5920	4420	
18	6640	6290	4890	

***NOTE:**
(A) - ALL 2 COURSE WALLS REQUIRE ONLY 200mm MINIMUM EMBEDMENT (W.N.O.)
(B) - FOR TYPE 2 - 2 COURSE WALLS HEADER BLOCKS ARE NOT REQUIRED

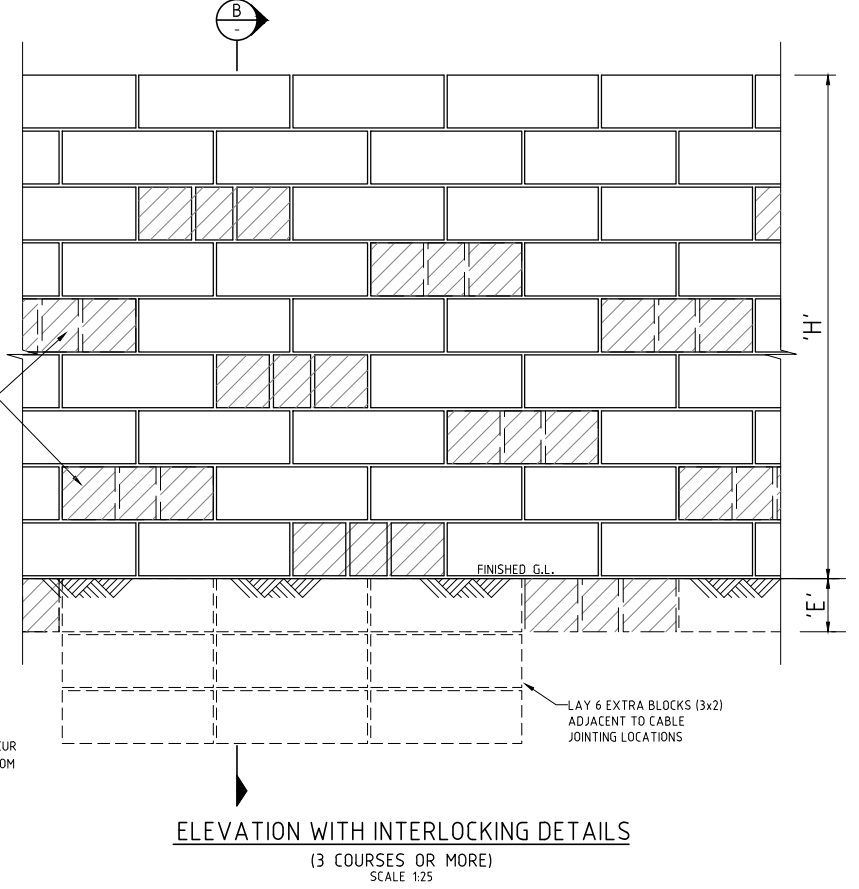
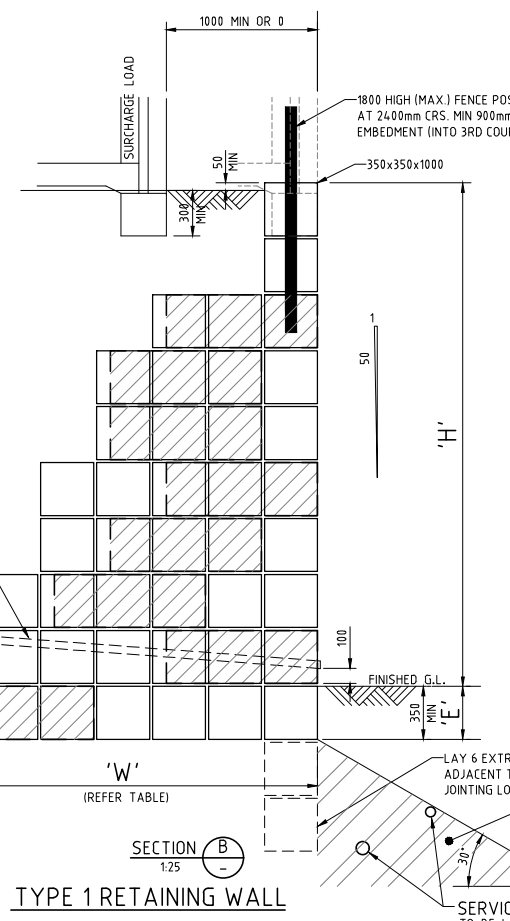
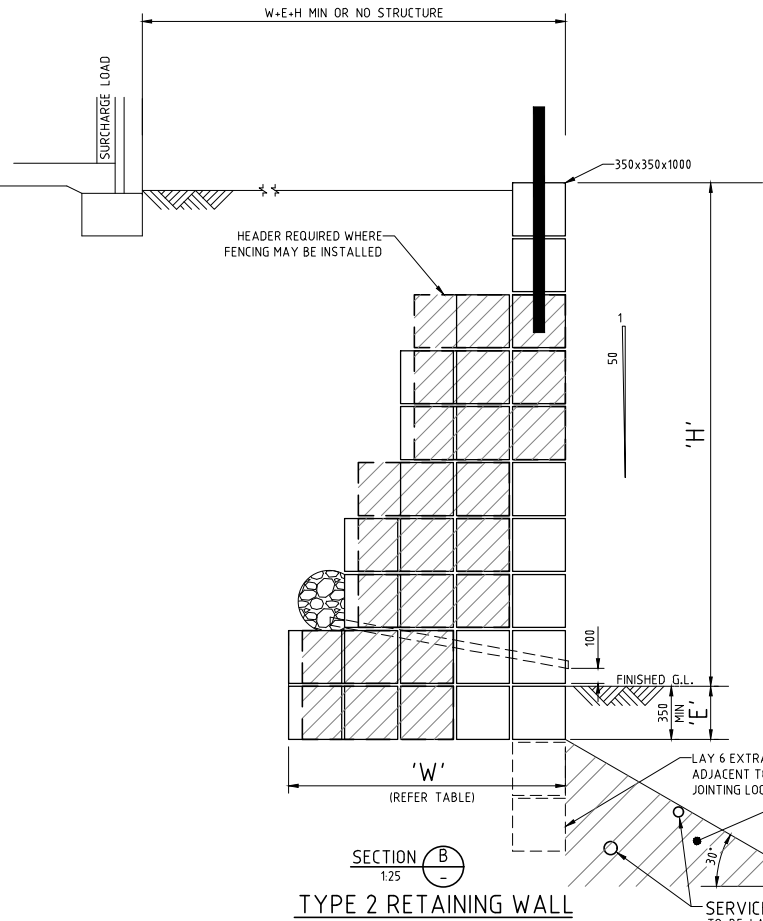

TYPE 1 = STRUCTURAL RETAINING WALL - STRUCTURE TO BE ON BOUNDARY OR MIN. 1.0m AWAY.

TYPE 2 = NON STRUCTURAL RETAINING WALL - NO STRUCTURE OR OFFSET MIN. OF (H + W + E)

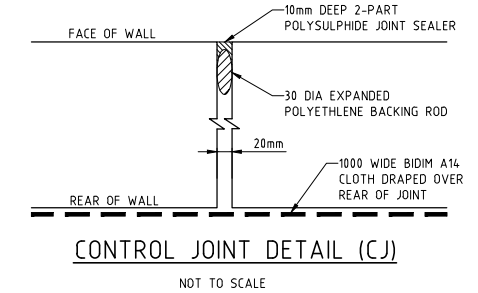
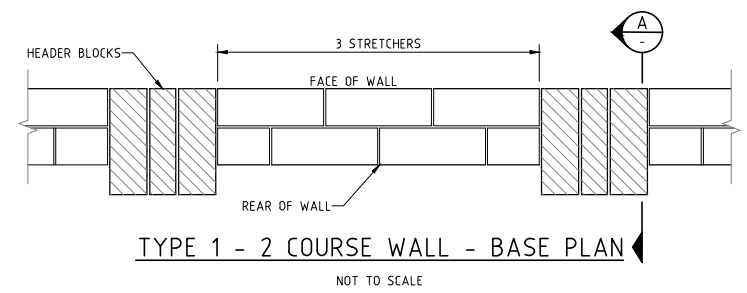
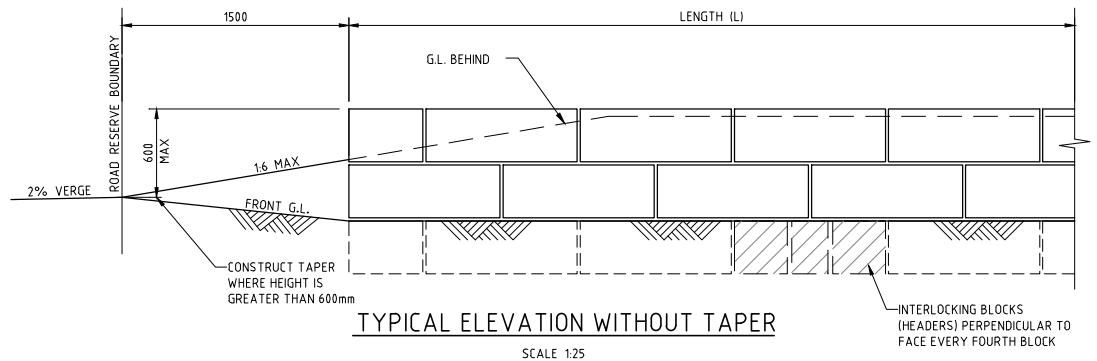
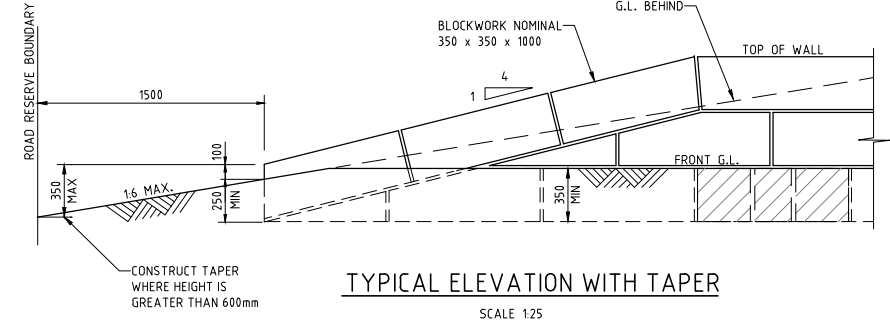

- NOTES:**
- DESIGN**
THE WALL IS DESIGNED FOR STABLE SAND (CLASS 'A') OR SLIGHTLY REACTIVE CONDITIONS (CLASS 'S') TO AS2870, WITH FREE DRAINING GRANULAR BACKFILL AND MIN 600mm SAND PAD BELOW BASE. FOUNDATION TO BE FREE OF DELETERIOUS MATERIAL. MAXIMUM WATER TABLE TO BE BELOW BOTTOM OF WALL, IF OTHER CONDITIONS ARE ENCOUNTERED ON SITE, CONTACT THE ENGINEER PRIOR TO CONSTRUCTION.
 - WALL TYPE 1**
DEAD LOADS (INCLUDING BUILDINGS) PLACED BEHIND WALLS SHOULD BE NO CLOSER THAN 1.0m UNLESS LOCATED DIRECTLY ON TOP. MAXIMUM SURCHARGE LOAD TO BE 40kN/m WHICH ALLOWS FOR A TWO STOREY BUILDING.
 - WALL TYPE 2**
ENSURE DEAD LOAD (INCLUDING BUILDINGS) PLACED BEHIND WALLS IS NO CLOSER TO THE WALL THAN A DISTANCE EQUAL TO H+E+W. MAXIMUM SURCHARGE LOAD TO BE 2.5kPa WHICH INCLUDES LIGHT VEHICLE SURCHARGE.
 - COMPACTION**
COMPACT THE SOIL AT THE BASE TO 100kPa ALLOWABLE BEARING CAPACITY OR 95% MODIFIED MAXIMUM DRY DENSITY FOR A MINIMUM DEPTH OF 600mm BELOW BASE OF WALL.
 - LIMESTONE**
LIMESTONE TO BE RECONSTITUTED BLOCKS (MINIMUM DENSITY OF 1800kg/m AND MINIMUM COMPRESSIVE STRENGTH OF 2MPa). FULL BLOCKS TO BE 350x350x1000, HALF BLOCKS TO BE 165x350x1000. ALTERNATIVELY 240x350x100 BLOCKS CAN BE USED TO MEET MINIMUM WALL DIMENSIONS. BLOCKS ARE TO BE LAID IN STRETCHER BOND. LIMESTONE TO BE FREE FROM SOFT POCKETS AND GENERALLY FREE FROM SURFACE DEFECTS.
 - INTERLOCKING BLOCKS**
FOR WALL TYPE 1 AND/OR WHEN FENCE POSTS ARE TO BE CORE DRILLED INTO WALL, PROVIDE INTERLOCKING BLOCKS (HEADERS) AT 4m CENTRES. LOCATE AT 3c AND EACH COURSE THEREAFTER WITH INTERLOCKING SETS TO BE STAGGERED WITH ADJACENT COURSE.
 - JOINTS**
ALL JOINTS ARE TO BE MORTARED WITH 1:1:6 (CEMENT:LIME:SAND). MORTAR TO BE M3 CLASSIFICATION, EXCEPT PROJECTS LOCATED WITHIN 1km OF THE OCEAN ARE TO BE M4 CLASSIFICATION. CEMENTS OTHER THAN TYPE GP PORTLAND CEMENT & 100% WHITE PORTLAND CEMENT SHALL NOT BE USED. RUBBLE NOT TO BE USED TO FILL VOIDS. ALL JOINTS ARE TO BE 20mm.
 - BACKFILL**
DO NOT BACKFILL WALL UNTIL AT LEAST 7 DAYS AFTER COMPLETION. BACKFILL TO BE COMPACTED TO A 95% MODIFIED MAXIMUM DRY DENSITY OR EQUIVALENT.
 - CONTROL JOINTS**
PROVIDE 20mm CONTROL JOINTS WHERE SHOWN ON DESIGN DRAWINGS OR OTHERWISE AT MAX 4m CENTRES IN STRAIGHT LENGTHS OF WALLS. WHERE WALL CHANGES DIRECTION, CONTROL JOINTS ARE LOCATED 1m FROM THE CORNER FOR WALLS TO 4c IN HEIGHT, 1.5m FOR WALLS BETWEEN 5c AND 8c IN HEIGHT, AND 2m FROM THE CORNER FOR WALLS 9c AND ABOVE. FILL JOINTS WITH 30DIA EXPANDED POLYETHYLENE BACKING ROD, COVERED WITH A 10mm 2-PART POLYSULPHIDE JOINT SEALER.
 - LOCATION**
RETAINING WALLS TO BE LOCATED WHOLLY WITHIN THE RETAINED LOT. FOOTING BLOCKS SHALL BE LOCATED TO A MAXIMUM TOLERANCE OF 25mm WITHIN THE RETAINED LOT, AND 0mm OUTSIDE THE CADASTRAL BOUNDARY OF THE RETAINED LOT.
 - COMPLETION**
THE CONTRACTOR SHALL PROVIDE WRITTEN CERTIFICATION OF PRACTICAL COMPLETION THAT THE WALL CONSTRUCTION AND BACKFILLING HAS BEEN CARRIED OUT IN ACCORDANCE WITH THIS DRAWING & SPECIFICATIONS. ALL WALLS FACING ROAD RESERVES, P.A.W.'S & P.O.S.'S ARE TO BE TREATED WITH A NON SACRIFICIAL ANTI-GRAFFITI COATING.

